

ENERGIZER EN95

D

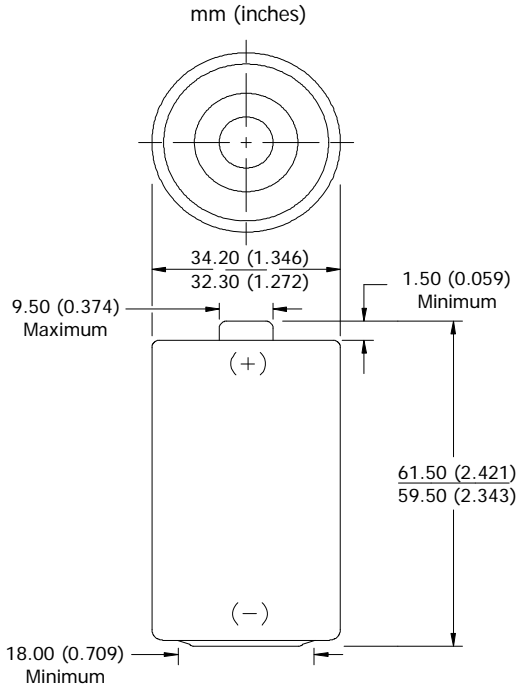

Industry Standard Dimensions



Specifications

NOT INTENDED FOR RETAIL TRADE

Classification:	Alkaline
Chemical System:	Zinc-Manganese Dioxide (Zn/MnO ₂) No added mercury or cadmium
Designation:	ANSI-13A, IEC-LR20
Nominal Voltage:	1.5 volts
Nominal IR:	150 to 300 milliohms (fresh)*
Operating Temp:	-18°C to 55°C (0°F to 130°F)
Typical Weight:	148.0 grams (5.2 oz.)
Typical Volume:	56.0 cubic centimeters (3.4 cubic inch)
Jacket:	Plastic Label
Shelf Life:	7 years at 21°C (80% of initial capacity)
Terminal:	Flat Contact

* For additional information, please reference the [IR technical white paper](#).

Milliamp-Hours Capacity

Continuous discharge to 0.8 volts at 21°C

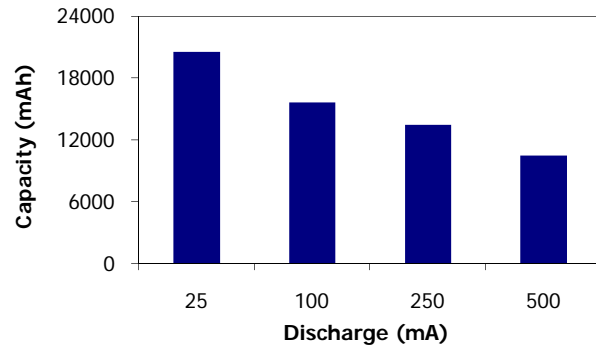

Constant Resistance Performance

Typical Characteristics (21°C)

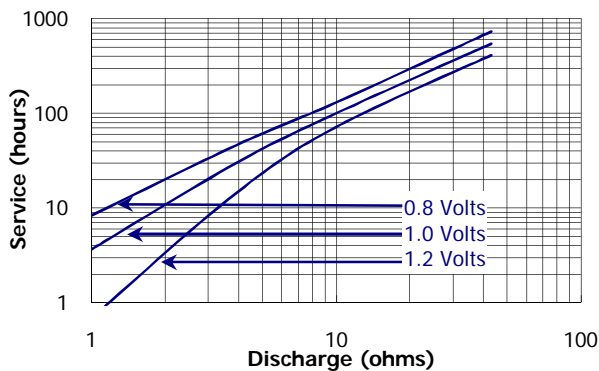

Constant Current Performance

Typical Characteristics (21°C)

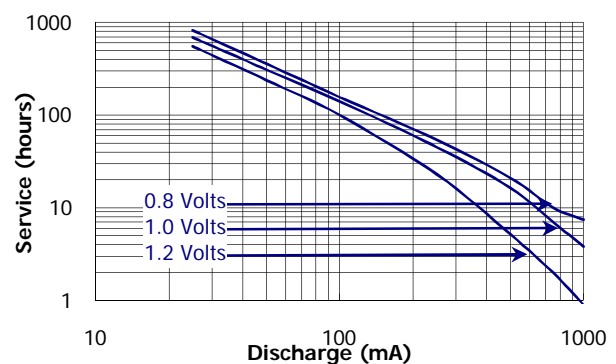

Important Notice

This data sheet contains typical information specific to products manufactured at the time of its publication.
©Energizer Holdings, Inc. - Contents herein do not constitute a warranty.

ENERGIZER EN95



Industry Standard Tests (21°C)

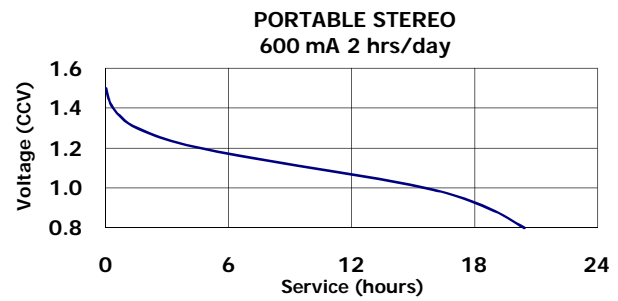
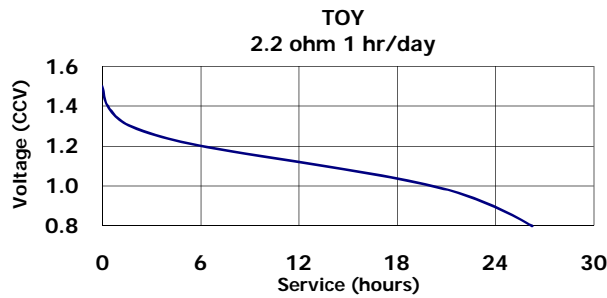
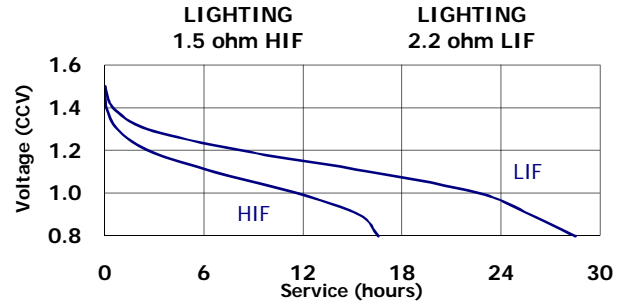
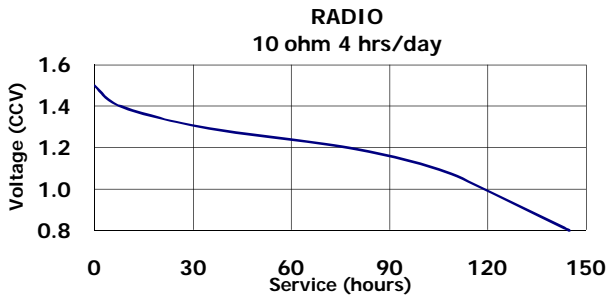

Important Notice

This data sheet contains typical information specific to products manufactured at the time of its publication.
©Energizer Holdings, Inc. - Contents herein do not constitute a warranty.